

**SIRUBA®**

銀爺牌工業用縫紉機

INDUSTRIAL SEWING MACHINE

**L818F-NF**

零件圖 PARTS LIST



CE



高林股份有限公司  
KAULIN MFG. CO., LTD.









								
MODEL	SUB-CLASS	NEEDLE PLATE	FEED DOG	PRESSER FOOT	HOOK ASM	BOBBIN CASE ASM	BOBBIN	NEEDLE
機型	規格	針板	送具	押具	梭頭	梭殼	梭子	針號
L818F-NM1	薄至中厚布料	E706	D704	P708	G123	G201	G301	DB*1#14
L818F-NH1	中厚至厚布料	E707	D714	P714	G124	G201	G301	DB*1#22

# 別件對照表 MODEL COMPARE LIST

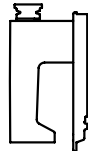
MODEL 機 型	SUB-CLASS 規 格	SPRING 控線彈簧	SPRING 控線彈簧	SPRING 挑線彈簧	THREAD GUIDE 擋環片	SPRING 壓簧	THREAD GUIDE 導線杆	EJECTOR PIN 頂出銷	ADJUSTING KNOB 調整旋鈕	REGULATOR 調整銷
L818F /NM1	薄布料 ~ 中厚料	LA31	LA22	LA27	A LA17	LB204	LN72	LB12	LC23G	LH11
					B SK613					
L818F /NH1	中厚料 ~ 厚布料	LA131	LA122	LA27	A LA150	LB04	LN72	LB12	LC623G	LH11
					B SK689					

MODEL 機 型	SUB-CLASS 規 格	CONNECTING ROD SENT 連桿座	FIXED PIN 固定銷	HOOK FIXER 旋梭定位板	THRAD TAKE UP LEVER 天秤	CRANK SHAFT 曲軸	THREAD GUIDE 導線環片	NEEDLE BAR 針棒	SPRING 拉伸彈簧	ECCENTRIC 偏心凸輪
L818F /NM1	薄布料 ~ 中厚料	LN35D	LC13	LE14	LG13	LG15	LG109	LN37	LN31	LN38
L818F /NH1	中厚料 ~ 厚布料	LN68	LC613	LE614	LG13	LG15	LG109	LN62	LN31	LN63



 MODEL 機 型	 SUB-CLASS 規 格	 MOVABLE KNIFE CONNECTING ROD 活動刀連桿	 MOVABLE KNIFE CONNECTING ROD 活動刀連桿	 PRESSER PLATE 刀座	 MOVABLE KNIFE 轉子連桿	 TRIMMER SOLENOID 切線電磁閥
L818F /NM1	薄布料 ~ 中厚料	LU01	—	LU03	LU18	LU25
L818F /NH1	中厚料 ~ 厚布料	—	LU601	LU603	LU618	LU625

# 別件對照表 MODEL COMPARE LIST

H1

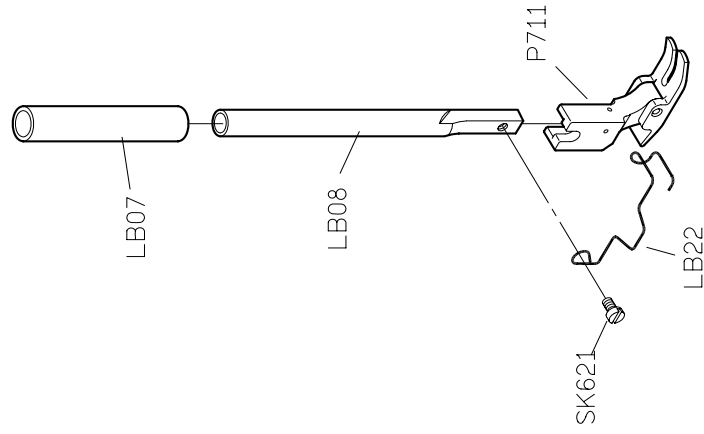

H1R

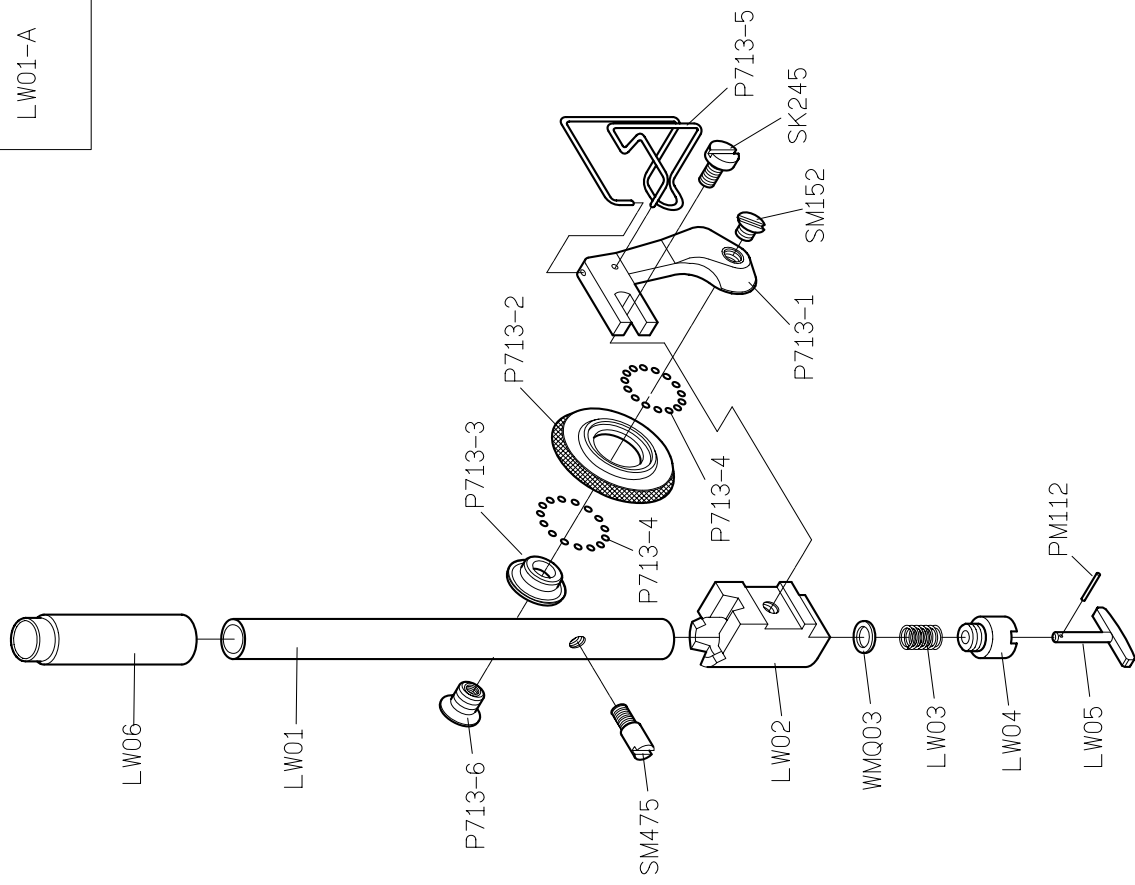

LW01-A



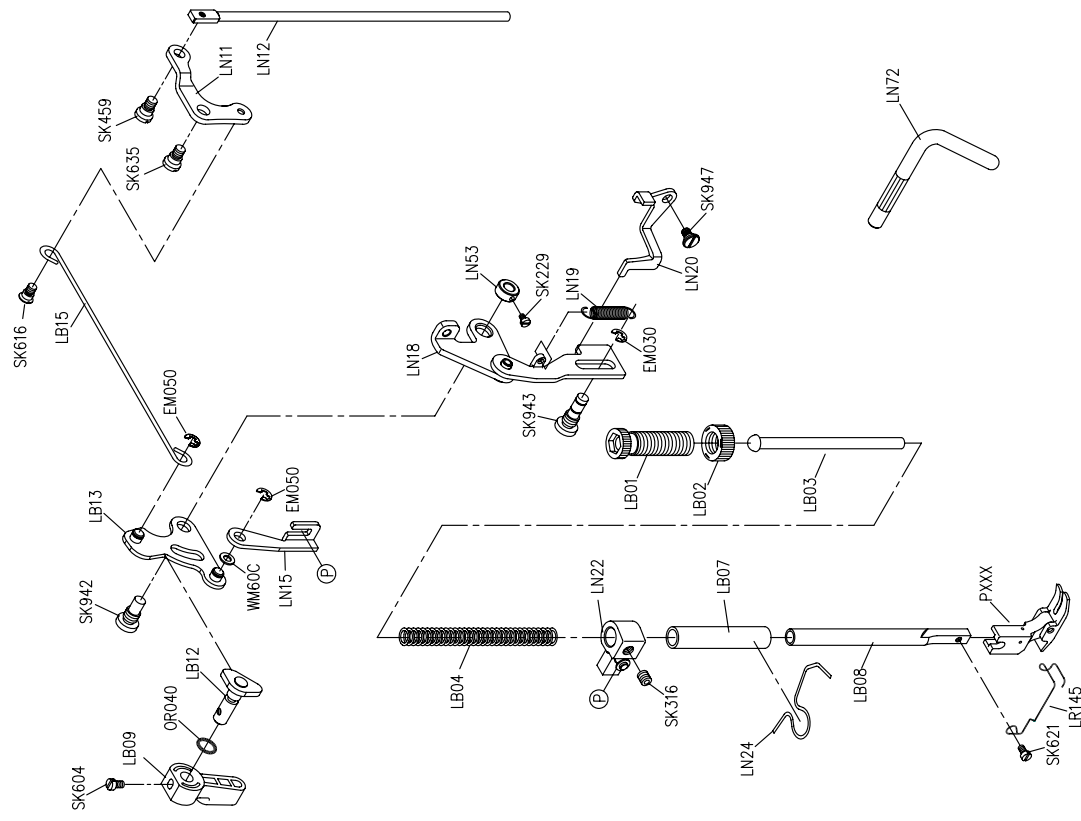

PARTS LIST FOR LB GROUP

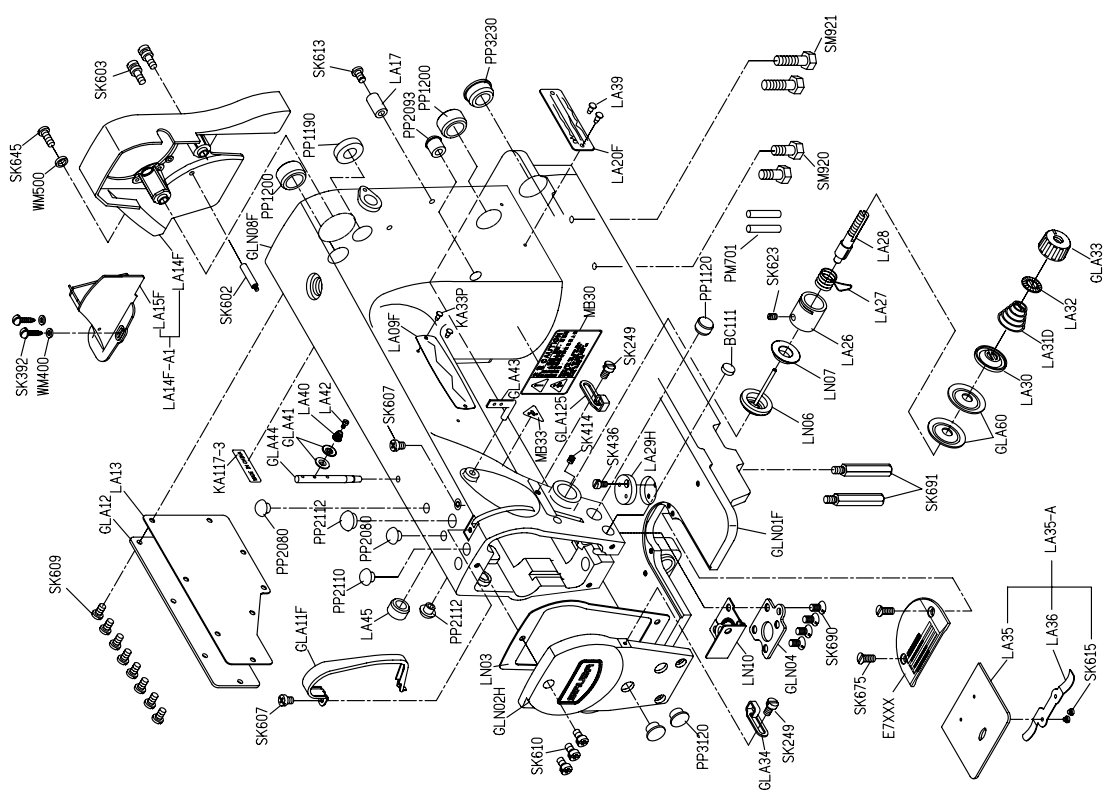

PARTS LIST FOR LA GROUP

# PARTS LIST FOR LC GROUP

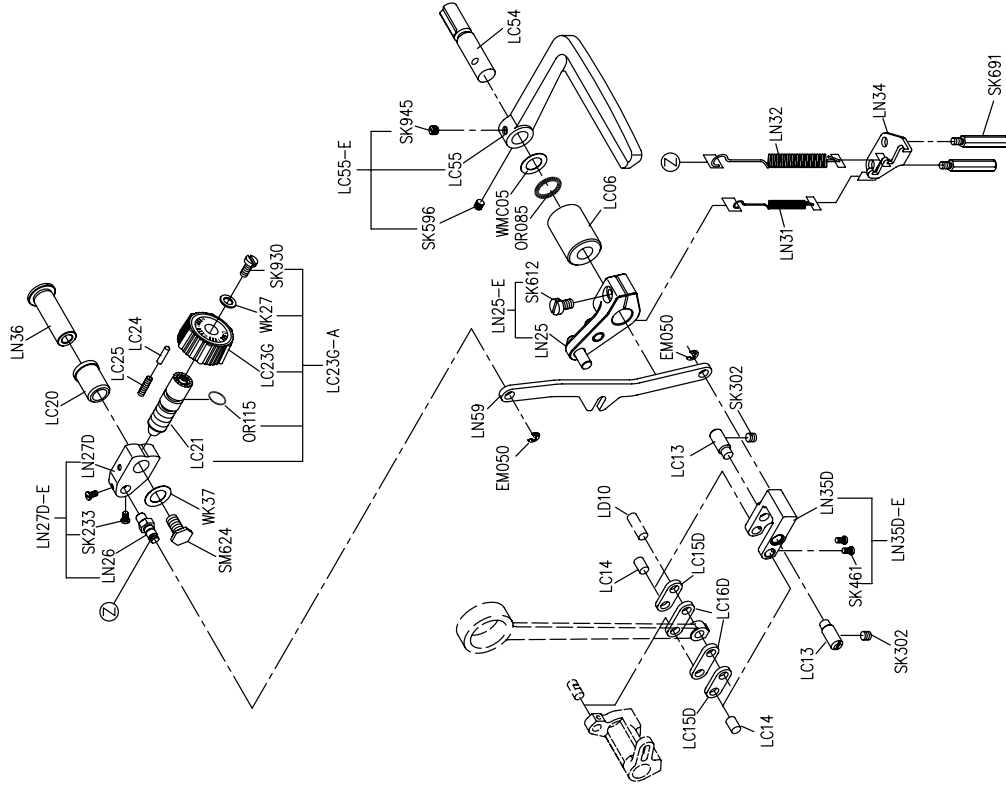

# PARTS LIST FOR LD GROUP

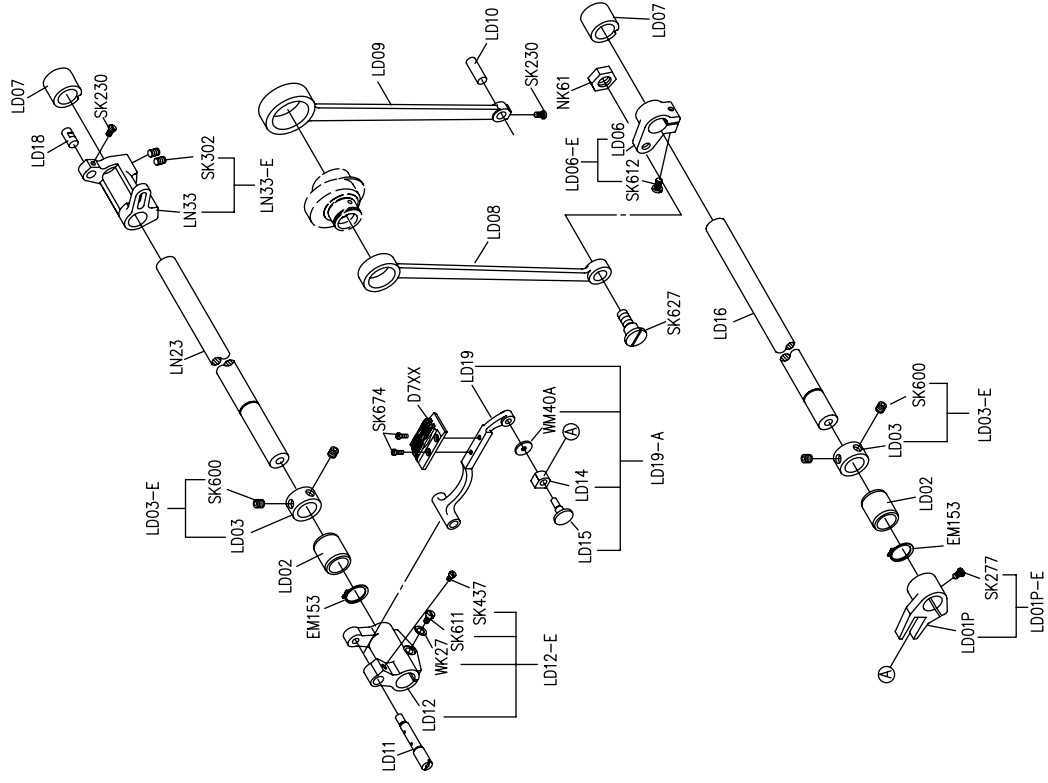

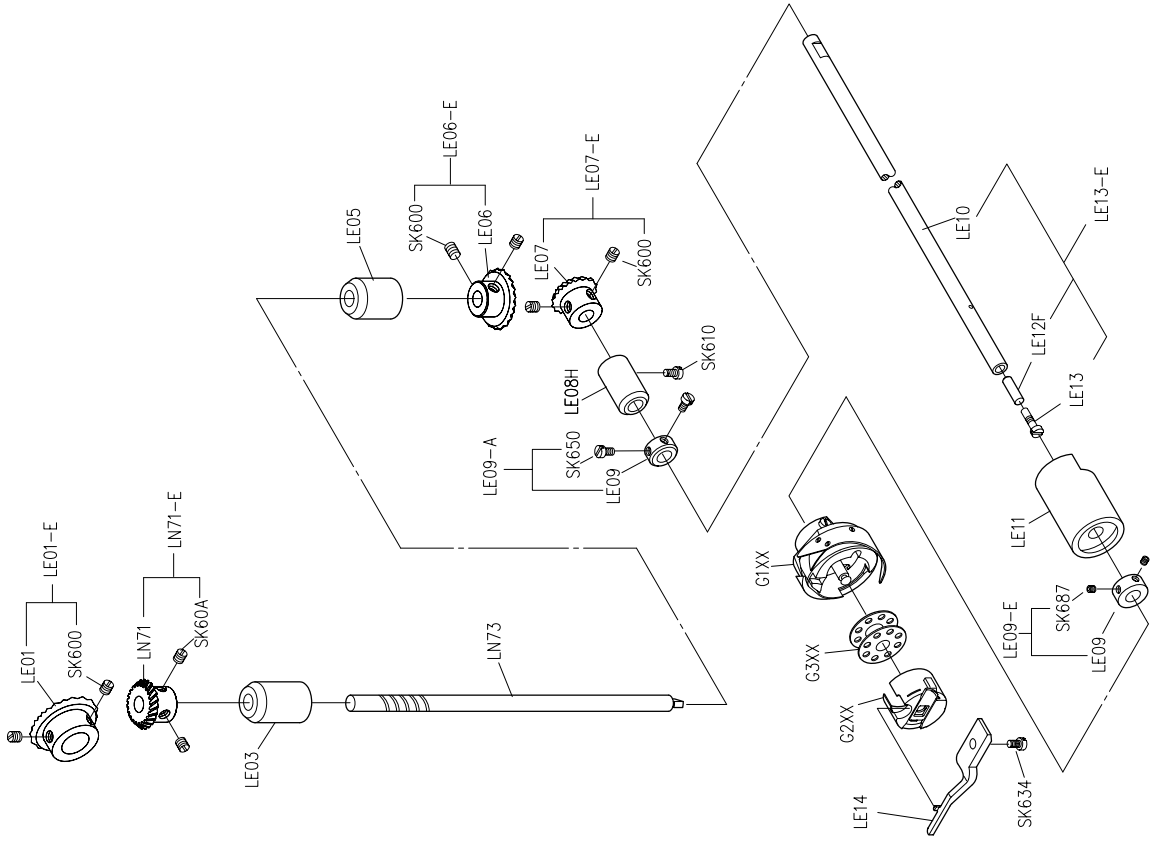

PARTS LIST FOR LE GROUP

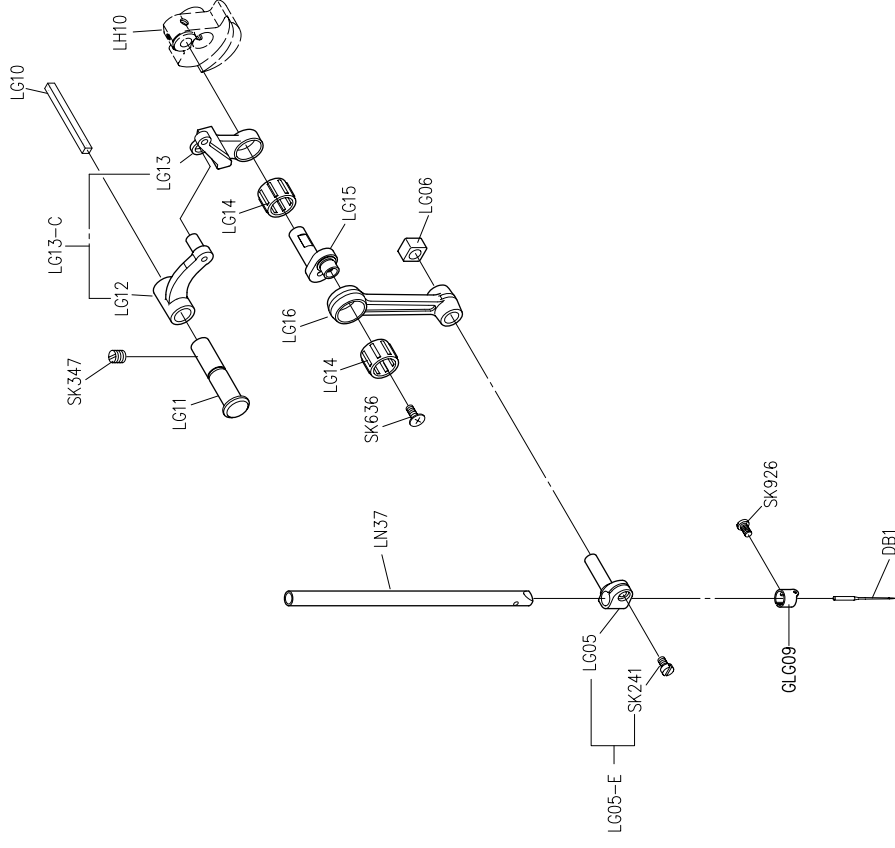

PARTS LIST FOR LG GROUP











# L818F-NF

高林股份有限公司 KAULIN MFG. CO., LTD.